

2.50mm (0.098") Pin Housing

XH Series

FEATURES

2-20 Circuits
 Post: Brass, Copper-Undercoated,
 Tin/Lead-Plated
 Wafer: Nylon, UL 94V-0

SPECIFICATIONS

Current Rating: 3A AC DC
 Voltage Rating: 250V AC Maximum
 Temperature Range: -25°C~+90°C
 Contact Resistance: Initial Value/10 m ohm max
 After Environmental Testing
 /20 m ohm min
 Insulation Resistance: 1000 M ohm min
 Withstand Voltage: 1500V AC/minute
 P.C.Board Thickness: 1.6mm(.063")

Contact

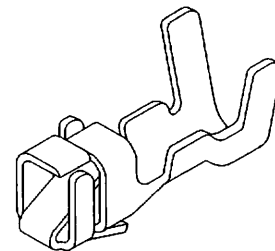
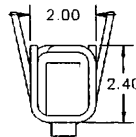
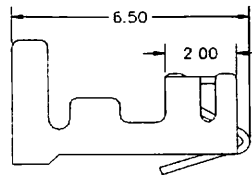

Model No.	Applicable Wire			Material	Finish
	mm ²	AWG #	Insulation O.D.		
XH-C-1	0.08 to 0.33	28 to 22	1.2 to 1.9	Phosphor Bronze	Tin-Plated
XH-C-2	0.05 to 0.13	30 to 26	0.9 to 1.3		

Housing

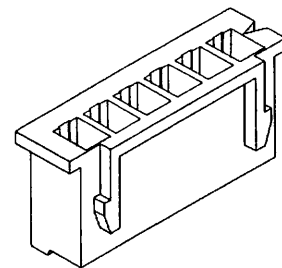
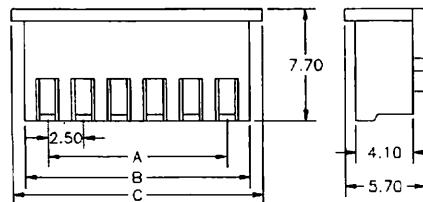
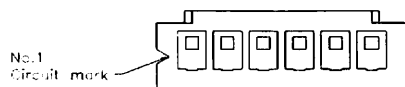

Circuits	Model No.	Dimension mm		
		A	B	C
2	XH-H- 2	2.5	5.7	7.3
3	XH-H- 3	5.0	8.2	9.8
4	XH-H- 4	7.5	10.7	12.3
5	XH-H- 5	10.0	13.2	14.8
6	XH-H- 6	12.5	15.7	17.3
7	XH-H- 7	15.0	18.2	19.8
8	XH-H- 8	17.5	20.7	22.3
9	XH-H- 9	20.0	23.2	24.8

Circuits	Model No.	Dimension mm		
		A	B	C
10	XH-H-10	22.5	25.7	27.3
11	XH-H-11	25.0	28.2	29.8
12	XH-H-12	27.5	30.7	32.3
13	XH-H-13	30.0	33.2	34.8
14	XH-H-14	32.5	35.7	37.3
15	XH-H-15	35.0	38.2	39.8
20	XH-H-20	47.5	50.7	52.3

SINGATRON ENT. CO., LTD. Tel.: (909) 464-1883 Fax.: (909) 464-1884

2.50mm (0.098") Pin Wafer

XH Series

Top Entry Type

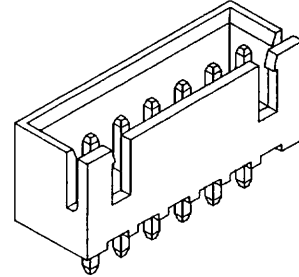
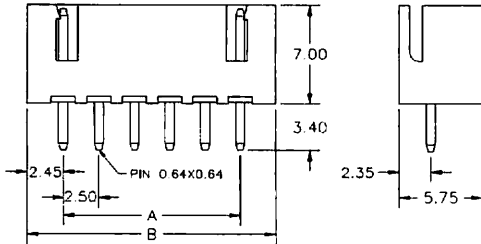

Side Entry Type

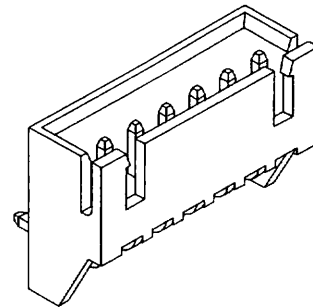
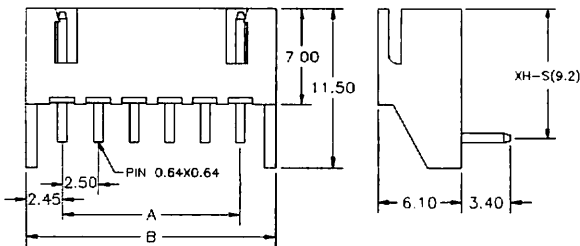

Circuits	Model No.		Dimension mm	
	Top Entry	Side Entry	A	B
2	XH-T- 2	XH-S- 2	2.5	7.4
3	XH-T- 3	XH-S- 3	5.0	9.9
4	XH-T- 4	XH-S- 4	7.5	12.4
5	XH-T- 5	XH-S- 5	10.0	14.9
6	XH-T- 6	XH-S- 6	12.5	17.4
7	XH-T- 7	XH-S- 7	15.0	19.9
8	XH-T- 8	XH-S- 8	17.5	22.4
9	XH-T- 9	XH-S- 9	20.0	24.9

Circuits	Model No.		Dimension mm	
	Top Entry	Side Entry	A	B
10	XH-T-10	XH-S-10	22.5	27.4
11	XH-T-11	XH-S-11	25.0	29.9
12	XH-T-12	XH-S-12	27.5	32.4
13	XH-T-13	XH-S-13	30.0	34.9
14	XH-T-14	XH-S-14	32.5	37.4
15	XH-T-15	XH-S-15	35.0	39.9
20	XH-T-20	-	47.5	52.4

DIP Type P.C.Board Layout

Top Entry Type

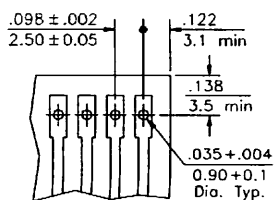

Side Entry Type

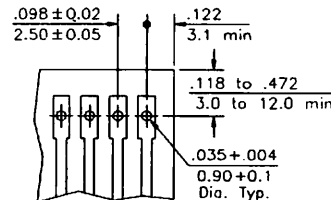

SINGATRON ENT. CO., LTD. Tel.: (909) 464-1883 Fax.: (909) 464-1884