

REVISIONS				
LTR	DESCRIPTION	DATE	REVISED	APPROVED
Δ XI		1999/04/06		

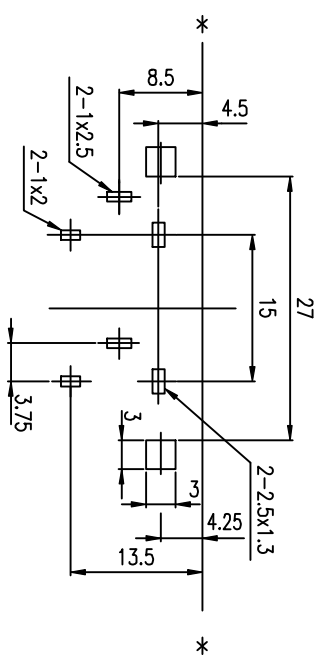
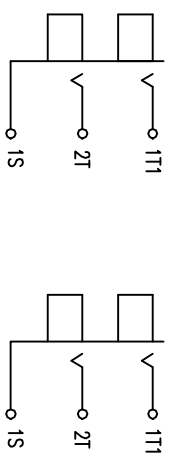
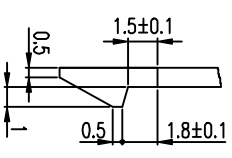
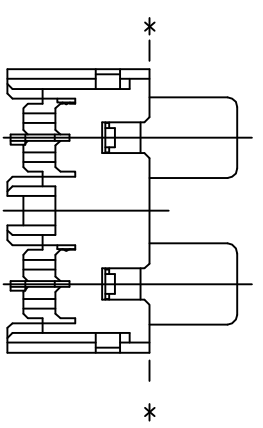
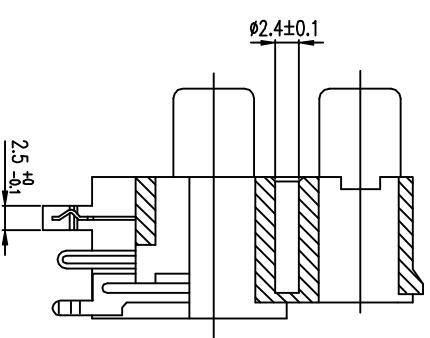
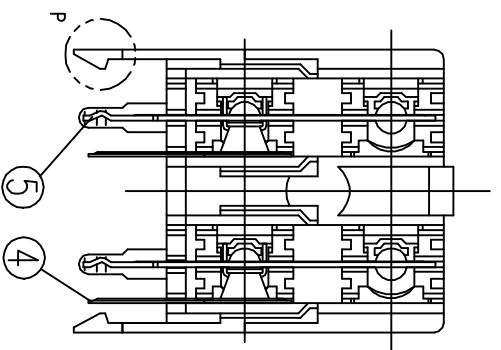
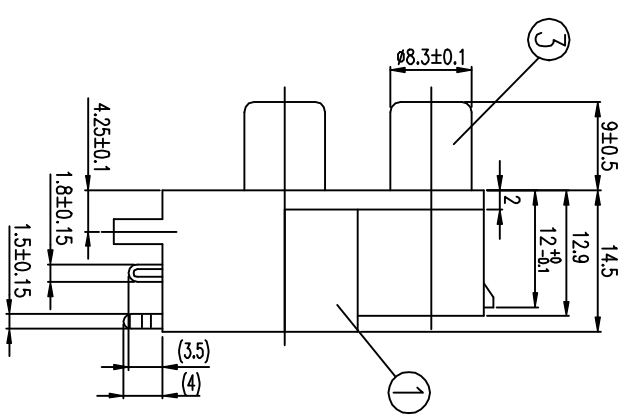
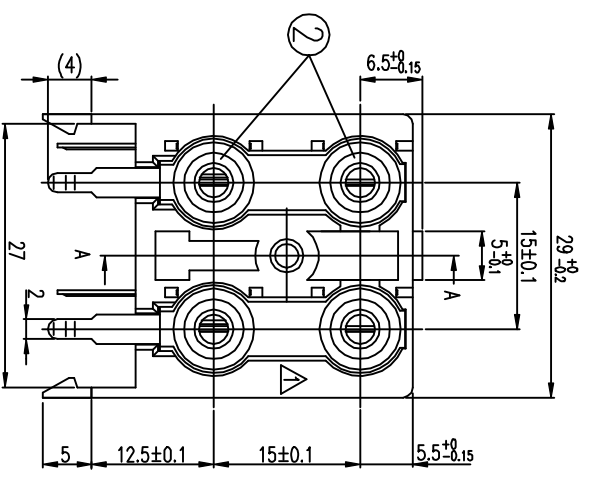

I:1.6 Dimension of PC board holes  
 Tolerance : ±0.1 (Printed-side View)  
 RECOMMAND P.C.B. HOLE LAYOUT

UNLESS OTHERWISE SPECIFIED, TOLERANCE ON DECIMAL: ±0.3 FRACTIONS: ANGLES:

LTR	PART NAME	QTY	MATERIAL (THICK, COLOR)	REMARK
5	TERMINAL	2	C2680	t=0.5 MB:Cu Sn/Pb PLATED
4	TIP SPRING	2	C5212	t=0.4 MB:Cu Sn/Pb PLATED
3	OUTER CONTACT	2	SPCC	t=0.4 MB:Cu NI PLATED
2	WASHER	4	ABS	UL-94HB
1	HOUSING	1	ABS	UL-94HB

DSND	DATE	SCALE	NAME
DWN	DATE	2/1	PIN JACK

CHKD	DATE	3RD ANGLE PROJECTION	CAT. NO.
APVD	DATE	UNIT: mm	HTJ-036-22B-

SINGATRON ENTERPRISE CO., LTD. (U.S.A.)	DWN:NO.	A-3622B	003
---	---------	---------	-----