

REVISIONS				
LTR	DESCRIPTION	DATE	REVISED	APPROVED
Δ x1			H.P.Liu	C.H.Chong
Δ x2			H.Y.Chou	Kung
Δ x2	(R0.5), 12.5±1-12.5±0.4		H.Y.Chou	Kung
Δ x1			H.P.Liu	

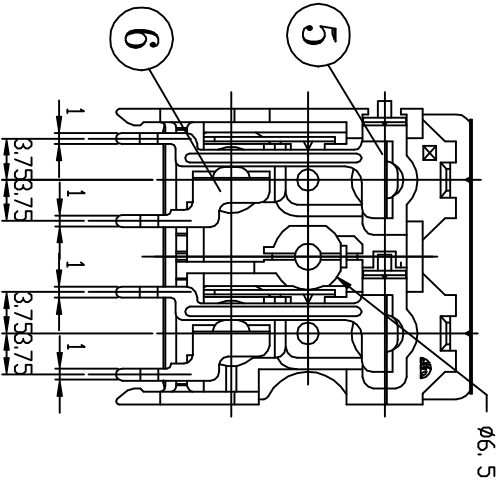

HOLE LAYOUT (TOLERANCE ±0.1)
(BOTTOM VIEW)

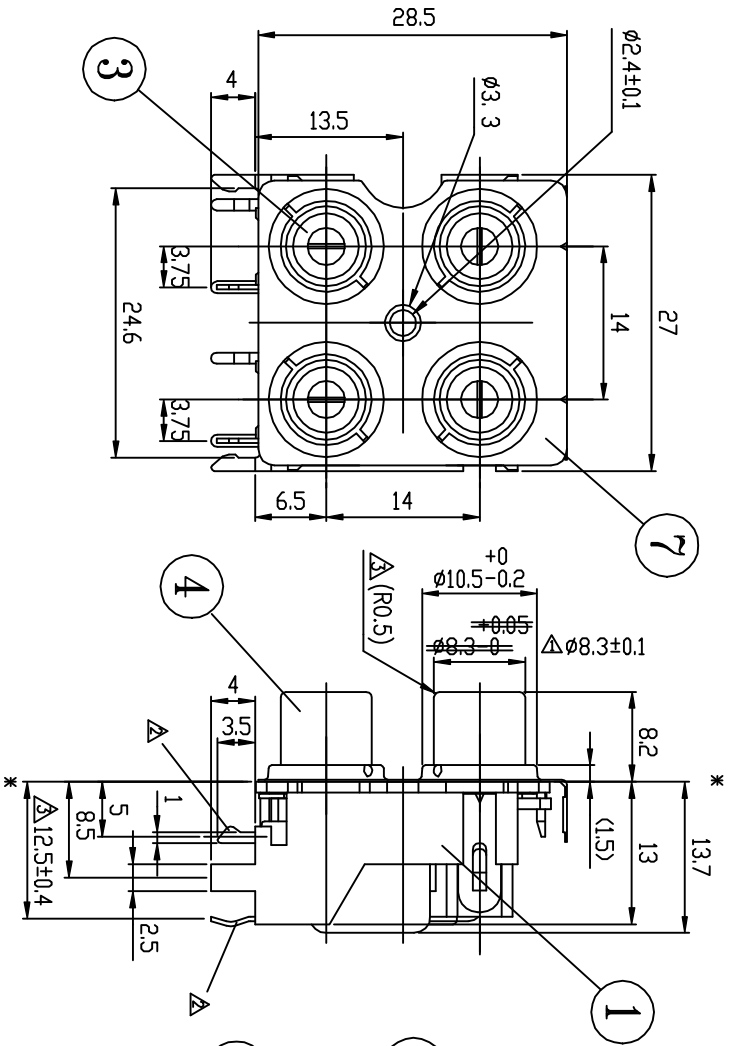
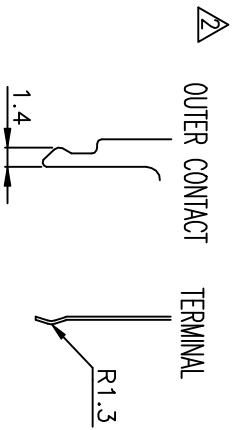
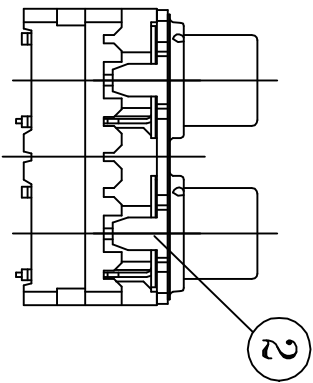

LTR	PART NAME	QTY	MATERIAL	REMARK
7	SEALED PLATE	1	C2680 , t=0.2	Δ Ni MB : Cu Sn/Pb PLATED
6	TERMINAL	2	C2680 , t=0.4	MB : Cu Sn/Pb PLATED
5	TERMINAL	2	C2680 , t=0.4	MB : Cu Sn/Pb PLATED
4	OUTER CONTACT	2	C2680 , t=0.4	MB : Cu Ni PLATED
3	WASHER	2	ABS , UL-94HB	
2	COVER	1	ABS , UL-94HB	
1	HOUSING	1	ABS , UL-94HB	

DSND	DATE	SCALE	2/1	NAME
DWN	H.Y.CHOU	DATE	1997.11.07	PIN JACK
CHKD	DATE	3RD ANGLE PROJECTION		CAT. NO. HSP-244V10-
APVD	DATE	UNIT: mm		

SINGATRON ENTERPRISE CO., LTD. (U.S.A.) DWN.NO. A-244V10 001

UNLESS OTHERWISE SPECIFIED, TOLERANCE ON DECIMAL: ±0.3 FRACTIONS: ANGLES:

MODEL NO.	COLOR				FINISH			
	A	B(HOUSING)	C	D	E	F	G	H
HSP-244_SREIES								
HSP-244_-01_	WHITE	WHITE	RED	RED	NI	PB-SN	PB-SN	NI
HSP-244_-02_	BLACK	BLACK	BLACK	BLACK	NI	PB-SN	PB-SN	NI
HSP-244_-03_	WHITE	WHITE	RED	RED	AU	PB-SN	PB-SN	NI
HSP-244_-04_	BLACK	BLACK	RED	RED	NI	PB-SN	PB-SN	NI
HSP-244_-05_	RED	RED	WHITE	WHITE	NI	PB-SN	PB-SN	NI
HSP-244_-06_	RED	RED	WHITE	WHITE	AU	PB-SN	PB-SN	NI
HSP-244_-07_	RED	RED	WHITE	WHITE	AU	AU**	PB-SN	NI
HSP-244_-08_	YELLOW	YELLOW	RED	WHITE	NI	PB-SN	PB-SN	NI
HSP-244_-09_	RED	WHITE	RED	WHITE	NI	PB-SN	PB-SN	NI
HSP-244_-10_	WHITE	YELLOW	RED	YELLOW	NI	PB-SN	PB-SN	NI
HSP-244_-11_	WHITE	RED	WHITE	RED	NI	PB-SN	PB-SN	NI
HSP-244_-12_	YELLOW	WHITE	YELLOW	WHITE	NI	PB-SN	PB-SN	NI
HSP-244_-13_	YELLOW	YELLOW	YELLOW	YELLOW	NI	PB-SN	PB-SN	NI
HSP-244_-14_	YELLOW	BLACK	WHITE	RED	NI	PB-SN	PB-SN	NI
HSP-244_-15_	WHITE	YELLOW	WHITE	YELLOW	NI	PB-SN	PB-SN	NI
HSP-244_-16_	WHITE	WHITE	RED	RED	AU	AU**	PB-SN	NI
HSP-244_-17_	BLACK	BLACK	BLACK	BLACK	AU	PB-SN	PB-SN	NI
HSP-244_-18_	BLACK	BLACK	BLACK	BLACK	AU	AU**	PB-SN	NI
HSP-244_-19_	BLACK	BLACK	BLACK	BLACK	AU	AU**	AU**	AU**
HSP-244_-20_	RED	WHITE	YELLOW	BLACK	NI	PB-SN	PB-SN	NI
HSP-244_-21_	WHITE	BLACK	RED	BLACK	NI	PB-SN	PB-SN	NI
HSP-244_-22_	RED	BLACK	WHITE	BLACK	NI	PB-SN	PB-SN	NI
HSP-244_-23_	RED	RED	WHITE	WHITE	L-PB-SN	PB-SN	PB-SN	NI
HSP-244_-24_	WHITE	BLACK	RED	ORANGE	L-PB-SN	PB-SN	PB-SN	NI
HSP-244_-25_	WHITE	RED	BLACK	BLACK	NI	PB-SN	PB-SN	NI
HSP-244_-26_	BLACK	RED	BLACK	WHITE	NI	PB-SN	PB-SN	NI
HSP-244_-27_	RED	BLACK	WHITE	BLACK	L-PB-SN	PB-SN	PB-SN	NI
HSP-244_-28_	RED	BLACK	WHITE	ORANGE	L-PB-SN	PB-SN	PB-SN	NI
HSP-244_-29_	WHITE	WHITE	RED	RED	L-PB-SN	PB-SN	PB-SN	NI

Plating :

PB-SN : MBCu2-PbSn3

NI : MBCu1-Ni1.5

NI+DIP : MBCu1-Ni1.5

L-PB-SN : MBCu2-L-PbSn3

AU : MBNi4-Au0.03

AU** : MBNi2-Au0.05

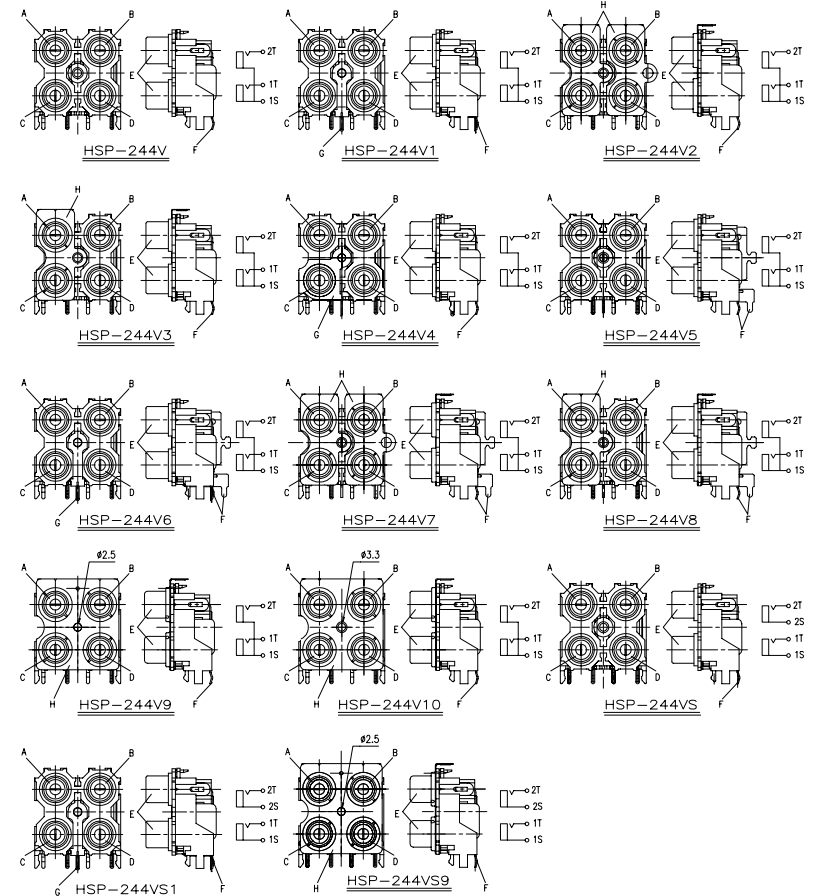

DWN	SIMON	DATE	2004.03.14	NAME: HSP-244 SERIES PARTS NO. TABLE
UPD	SIMON	DATE	2004.03.14	
CHKD	JOHNSON	DATE	2004.03.15	

SINGATRON U.S.A.			DWN. NO. E-244	1/4
				F

MODEL NO.	COLOR				FINISH			
	A	B(HOUSING)	C	D	E	F	G	H
HSP-244_SREIES								
HSP-244_-30_	BLUE	GREEN	RED	BROWN	NI	PB-SN	PB-SN	NI
HSP-244_-31_	BLUE	BLUE	RED	RED	NI	PB-SN	PB-SN	NI
HSP-244_-32_	WHITE	GREEN	RED	BROWN	NI	PB-SN	PB-SN	NI
HSP-244_-33_	YELLOW	WHITE	YELLOW	RED	NI	PB-SN	PB-SN	NI
HSP-244_-34_	WHITE	HOAR	RED	BROWN	NI	PB-SN	PB-SN	NI
HSP-244_-35_	WHITE	BLACK	RED	YELLOW	NI	PB-SN	PB-SN	NI
HSP-244_-36_	RED	ORANGE	WHITE	BLACK	L-PB-SN	PB-SN	PB-SN	NI
HSP-244_-37_	RED	WHITE	RED	WHITE	L-PB-SN	PB-SN	PB-SN	NI
HSP-244_-38_	BLACK	BLACK	BLACK	BLACK	L-PB-SN	PB-SN	PB-SN	NI
HSP-244_-39_	WHITE	BLACK	RED	BLACK	L-PB-SN	PB-SN	PB-SN	NI
HSP-244_-40_	WHITE	BLACK	RED	BLACK	AU	PB-SN	PB-SN	NI
HSP-244_-41_	YELLOW	YELLOW	BLACK	BLACK	AU	PB-SN	PB-SN	NI
HSP-244_-42_	RED	RED	WHITE	WHITE	NI+DIP	PB-SN	PB-SN	NI
HSP-244_-43_	WHITE	WHITE	RED	RED	NI+DIP	PB-SN	PB-SN	NI
HSP-244_-44_	WHITE	BLACK	RED	BLACK	NI+DIP	PB-SN	PB-SN	NI
HSP-244_-45_	RED	WHITE	RED	WHITE	NI+DIP	PB-SN	PB-SN	NI
HSP-244_-46_	WHITE	RED	WHITE	RED	NI+DIP	PB-SN	PB-SN	NI
HSP-244_-47_	WHITE	YELLOW	RED	ORANGE	NI	PB-SN	PB-SN	NI
HSP-244_-48_	YELLOW	RED	YELLOW	WHITE	NI	PB-SN	PB-SN	NI
HSP-244_-49_	WHITE	HOAR	RED	BLACK	NI	PB-SN	PB-SN	NI
HSP-244_-50_	WHITE	HOAR	RED	BLACK	AU	PB-SN	PB-SN	NI
HSP-244_-51_	ORANGE	ORANGE	ORANGE	ORANGE	AU	AU**	AU**	NI
HSP-244_-52_	RED	WHITE	BLACK	ORANGE	L-PB-SN	PB-SN	PB-SN	NI
HSP-244_-53_	BLACK	BLACK	RED	WHITE	L-PB-SN	PB-SN	PB-SN	NI
HSP-244_-54_	BLACK	WHITE	BLACK	RED	NI	PB-SN	PB-SN	NI
HSP-244_-55_	ORANGE	WHITE	BLACK	RED	NI	PB-SN	PB-SN	NI
HSP-244_-56_	HOAR	YELLOW	BROWN	YELLOW	AU	PB-SN	PB-SN	NI
HSP-244_-57_	RED	WHITE	RED	WHITE	AU	PB-SN	PB-SN	NI
HSP-244_-58_	RED	WHITE	RED	WHITE	AU	PB-SN	PB-SN	AU**
HSP-244_-59_	RED	ORANGE	WHITE	YELLOW	NI	PB-SN	PB-SN	NI

Plating :

PB-SN : MBCu2-PbSn3

NI : MBCu1-Ni1.5

NI+DIP : MBCu1-Ni1.5

L-PB-SN : MBCu2-L-PbSn3

AU : MBNi4-Au0.03

AU** : MBNi2-Au0.05

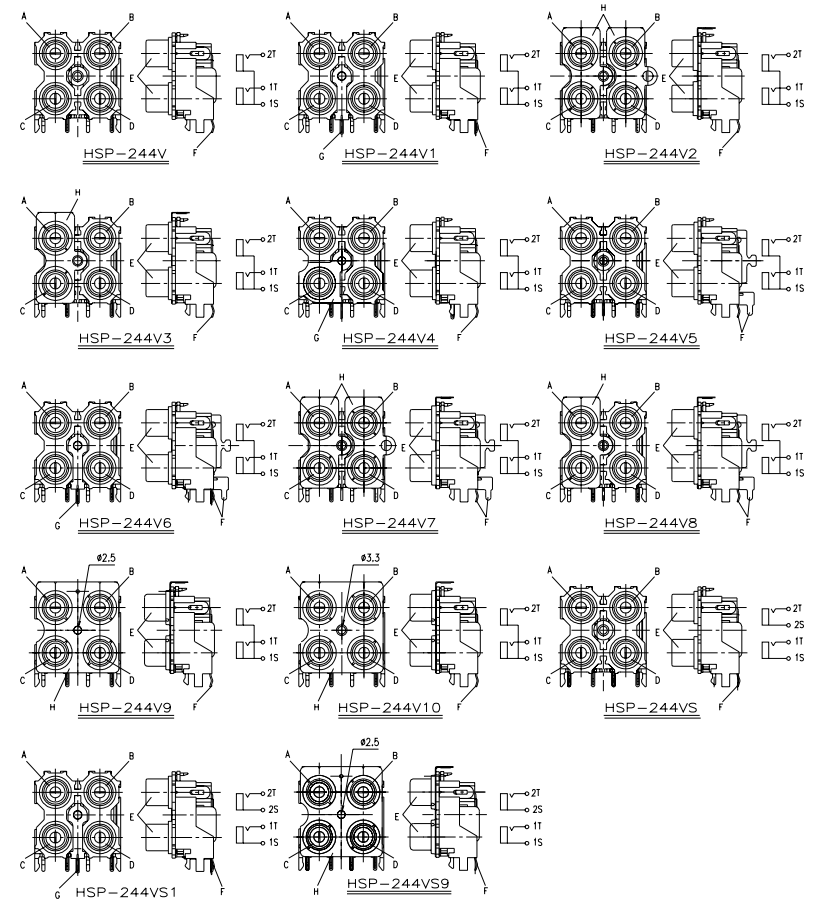

DWN	SIMON	DATE	2004.03.14	NAME: HSP-244 SERIES PARTS NO. TABLE	
UPD	SIMON	DATE	2004.03.14		
CHKD	JOHNSON	DATE	2004.03.15		
SINGATRON U.S.A.				DWN. NO. E-244	2/4
					F

MODEL NO. HSP-244 SREIES	COLOR				FINISH			
	A	B(HOUSING)	C	D	E	F	G	H
HSP-244_-60_	RED	RED	SNOWY WHITE	SNOWY WHITE	NI	PB-SN	PB-SN	NI
HSP-244_-61_	BLACK	BLACK	BLACK	BLACK	NI+DIP	PB-SN	PB-SN	NI
HSP-244_-62_	ORANGE	WHITE	YELLOW	RED	NI	PB-SN	PB-SN	NI
HSP-244_-63_	BLACK	WHITE	YELLOW	RED	NI	PB-SN	PB-SN	NI
HSP-244_-64_	YELLOW	BLUE	GREEN	RED	NI	PB-SN	PB-SN	NI
HSP-244_-65_	BLACK	BLACK	WHITE	RED	NI	PB-SN	PB-SN	NI
HSP-244_-66_	YELLOW	YELLOW	YELLOW	YELLOW	AU	PB-SN	PB-SN	NI
HSP-244_-67_	WHITE	RED	BLUE	RED	AU	PB-SN	PB-SN	NI
HSP-244_-68_	RED	RED	BLACK	BLACK	AU	PB-SN	PB-SN	NI
HSP-244_-69_	ORANGE	RED	BLACK	WHITE	NI	PB-SN	PB-SN	NI
HSP-244_-70_	YELLOW	YELLOW	WHITE	RED	NI	PB-SN	PB-SN	NI
HSP-244_-71_	GREEN	BLUE	YELLOW	RED	NI	PB-SN	PB-SN	NI
HSP-244_-72_	WHITE	WHITE	RED	RED	NI	AU**	PB-SN	NI
HSP-244_-73_	BLACK	BLACK	BLACK	BLACK	NI	AU**	PB-SN	NI
HSP-244_-74_	RED	RED	YELLOW	YELLOW	NI	PB-SN	PB-SN	NI
HSP-244_-75_	WHITE	WHITE	WHITE	WHITE	NI	PB-SN	PB-SN	NI
HSP-244_-76_	WHITE	WHITE	YELLOW	YELLOW	NI	PB-SN	PB-SN	NI
HSP-244_-77_	WHITE	RED	WHITE	RED	AU	PB-SN	PB-SN	NI
HSP-244_-78_	YELLOW	BLACK	RED	WHITE	NI	PB-SN	PB-SN	NI
HSP-244_-79_	GREEN	RED	YELLOW	BLUE	AU	PB-SN	PB-SN	NI
HSP-244_-80_	RED	RED	WHITE	WHITE	AU	AU**	AU**	AU**
HSP-244_-81_	WHITE	WHITE	RED	RED	AU	AU**	AU**	AU**
HSP-244_-82_	YELLOW	YELLOW	WHITE	WHITE	NI	PB-SN	PB-SN	NI
HSP-244_-83_	YELLOW	YELLOW	WHITE	WHITE	AU	PB-SN	PB-SN	NI
HSP-244_-84_	YELLOW	BLUE	GREEN	RED	AU	PB-SN	PB-SN	NI
HSP-244_-85_	RED	BLACK	WHITE	HOAR	AU	PB-SN	PB-SN	NI
HSP-244_-86_	GREEN	BLUE	PURPLE	HOAR	NI	PB-SN	PB-SN	NI
HSP-244_-87_	BLUE	WHITE	RED	YELLOW	NI	PB-SN	PB-SN	NI

Plating :

PB-SN : MBCu2-PbSn3

NI : MBCu1-Ni1.5

NI+DIP : MBCu1-Ni1.5

L-PB-SN : MBCu2-L-PbSn3

AU : MBNi4-Au0.03

AU** : MBNi2-Au0.05

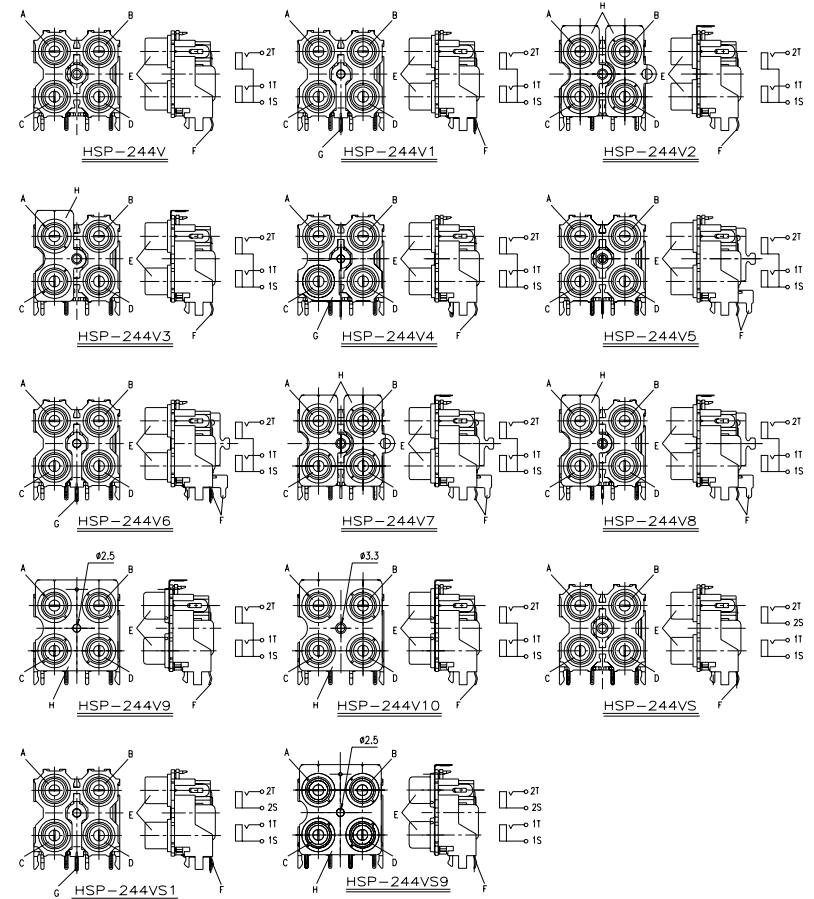

DWN	SIMON	DATE	2004.03.14	NAME: HSP-244 SERIES PARTS NO. TABLE	
UPD	SIMON	DATE	2004.03.14		
CHKD	JOHNSON	DATE	2004.03.15		
SINGATRON U.S.A.				DWN. NO. E-244	3/4 F

