

# DS SERIES

## D-SUB CONNECTOR, SOLDER TYPE

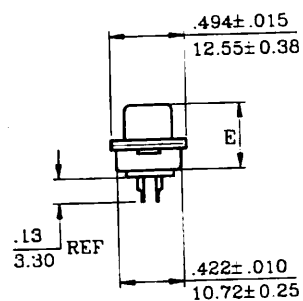
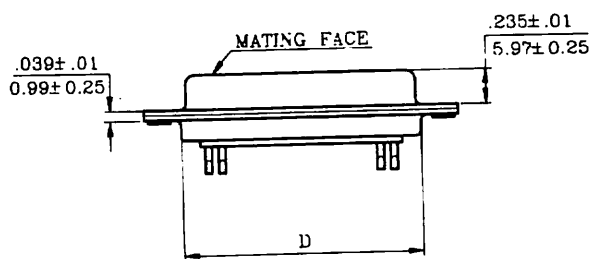
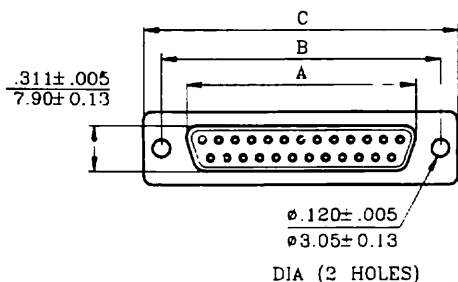
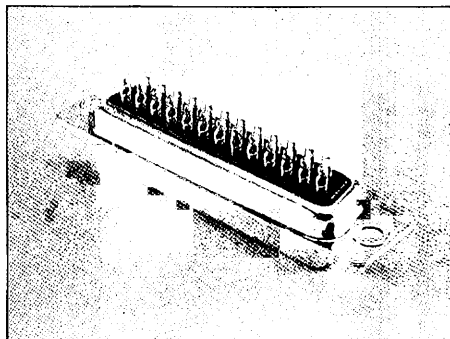

### DIMENSIONS

SHELL SIZE	A 0.010 0.25	B 0.005 0.13	C 0.015 0.38	D 0.010 0.25	E 0.015 0.38
9 (E)	0.643 16.33	0.984 24.99	1.213 30.81	0.759 19.28	0.429 10.90
15 (A)	0.971 24.66	1.313 33.32	1.541 39.14	1.083 27.51	0.429 10.90
19 (G)	1.208 30.68	1.526 38.76	1.764 44.81	1.299 32.99	0.429 10.90
23 (F)	1.401 35.60	1.751 44.48	1.980 50.30	1.491 37.87	0.429 10.90
25 (B)	1.511 38.38	1.852 47.04	2.088 53.04	1.625 41.28	0.429 10.90
37 (C)	2.159 54.84	2.500 63.50	2.729 69.32	2.272 57.71	0.429 10.90
50 (D)	2.064 52.43	2.406 61.11	2.635 66.93	2.178 55.32	0.429 10.90

• MOUNTING OPTIONS:  
 SEE PAGE 46

# MOUNTING OPTION

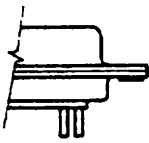

**OPTION X**  
 .120 DIAMETER HOLES

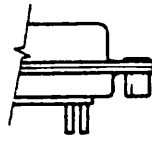

**OPTION K**  
 WITH #4-40 THREADED  
 RIVETED CLINCH NUTS

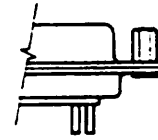

**OPTION J**  
 WITH #4-40  
 THREADED FIXED  
 JACK SCREWS

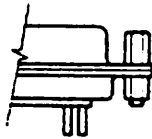

**OPTION KJ**  
 WITH #4-40 THREADED  
 RIVETED CLINCH NUTS  
 AND JACK SCREWS  
 ASSEMBLED TO  
 CONNECTOR

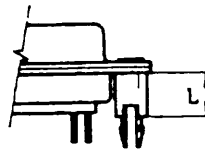

**OPTION BR**  
 WITH #4-40 THREADED  
 RIVETED BRACKETS

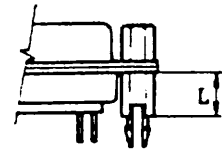

**OPTION BRJ**  
 WITH #4-40 THREADED  
 RIVETED BRACKET  
 AND JACK SCREWS  
 ASSEMBLED TO  
 CONNECTOR

SERIES	MOUNTING OPTIONS
DDF	X, K, J, KJ, BR, BRJ (L = 8.50MM)
DDL	X, K, J, KJ, BR, BRJ (L = 14.50MM)
DSF	X, K, J, KJ
DCC	X, K, J, KJ
DS	X, K, J, KJ
DSH	X, K, J, KJ
DD	X, K, J, KJ, BR, BRJ (L = 6.00MM)
DDH	X, K, J, KJ, BR, BRJ (L = 6.00MM)
DDL	X, K, J, KJ, BR, BRJ (L = 11.00MM, 12.70MM)
DDLH	X, K, J, KJ, BR, BRJ (L = 9.65MM, 11.00MM, 12.70MM)
DC	X, K, J, KJ
DCH	X, K, J, KJ
DIDC	X, K, J, KJ
DMR	X, K, J, KJ
DMRM	X, K, J, KJ
DMRL	X, K, J, KJ

# HOW TO ORDER

$\frac{DR}{1} - \frac{A}{2} \frac{15}{3} \frac{S}{4} - \frac{NJ}{5} - \frac{0}{6} \frac{0}{7} \frac{0}{8} - \frac{C}{9}$

$\frac{DP}{1} - \frac{E}{2} \frac{9}{3} \frac{S}{4} / \frac{E}{2} \frac{15}{3} \frac{S}{4} - \frac{ANJ}{5} - \frac{0}{6} \frac{0}{7} \frac{0}{8} - \frac{C}{9}$  (DUAL PORT ONLY)

TOP CONNECTOR      BOTTOM CONNECTOR

## 1. SERIES

## 2. SHELL SIZE

E - - - - - 9      B - - - - - 25

A - - - - - 15      C - - - - - 37

G - - - - - 19      D - - - - - 50

F - - - - - 23

## 3. NO. OF CONTACTS

9, 15, 19, 23, 25, 26, 37, 44, 50, 62, 78, 104

## 4. CONTACT TYPE

P : PIN CONTACT (PLUG), BRASS

S : SOCKET CONTACT (RECEPTACLE), PHOSPHOR BRONZE

SB : SOCKET CONTACT (RECEPTACLE), BRASS

## 5. MOUNTING OPTIONS

## 6. CONTACT FINISH

0: GOLD FLASH      4: 15  $\mu''$

1: SELECTIVE GOLD FLASH      5: 20  $\mu''$

2: 5  $\mu''$       6: 30  $\mu''$

3: 10  $\mu''$

## 7. INSULATOR COLOR

0: BLACK      2: BLUE

1: WHITE      3: GREY

## 8. SHELL PLATED

0: TIN      2: ZINC

1: NICKEL      3: ALL PLASTIC

## 9. CUSTOMER'S DESIGN

---

## FEATURES

- MEETS EIA, RS232C AND RS449 STANDARDS FOR DATA COMMUNICATION INPUT/OUTPUT CONNECTORS
- BRIGHT TIN SHELLS FOR EXCEPTIONAL CONDUCTIVITY AND GROUNDING
- INDENTATIONS (DIMPLES) FOR EXCEPTIONAL GROUNDING AND MATING RETENTION
- D SHAPE CONNECTOR MATING AND POLARIZATION
- SEVEN (7) SHELL SIZES
- FIVE (5) TYPES OF CONTACT TERMINATION, SOLDER CUP, SOLDER DIP, CRIMP, IDC AND RIGHT ANGLE
- TWO (2) TYPES OF CONTACT CONSTRUCTION, PRECISION MACHINED OR PRECISION FORMED
- ACCESSORIES ARE AVAILABLE

## PERFORMANCE SPECIFICATIONS

### MATERIALS AND FINISH

#### SHELL

STEEL MATERIAL, TIN FINISH AND IDENTIFICATIONS (DIMPLES) ON PLUG ONLY

#### INSERT

PBT THERMO PLASTIC, BLACK COLOR, 30% GLASS FILLED SELF EXTINGUISHING, 94V-0 RATED

#### CONTACT MATERIAL

PIN : BRASS  
SOCKET: PHOSPHOR BRONZE OR BRASS

### MECHANICAL CHARACTERISTICS

#### CONTACT RETENTION

PRECISION MACHINED CONTACT 10 LBS  
PRECISION FORMED CONTACT 10 LBS

#### CONTACT SEPARATION FORCE

4 OUNCES MIN

### ELECTRICAL CHARACTERISTICS

#### CONTACT CURRENT RATING

PRECISION MACHINED CONTACT 7.6 AMPS (WITH 20 AWG WIRE)  
PRECISION FORMED CONTACT 5.0 AMPS (WITH 20 AWG WIRE)

#### CONTACT RESISTANCE

PRECISION MACHINED CONTACT  
5 MILLIOHMS MAX  
PRECISION FORMED CONTACT  
8 MILLIOHMS MAX

### MILITARY AND FEDERAL SPECIFICATIONS

ASTM-B633	ZINC PLATING
QQ-B750	PHOSPHOR BRONZE
QQ-N-290	NICKEL PLATING
QQ-S-698	STEEL

#### CONTACT FINISH

GOLD FLASH OVER 100 MICRO INCH  
NICKEL ON ENTIRE CONTACT AREA.

#### GROUNDING BRACKET

BRASS MATERIAL, TIN FINISH

#### RIVETED INSERT

BRASS MATERIAL, NICKEL FINISH

#### JACK SCREW

BRASS MATERIAL,

#### CONTACT ENGAGEMENT FORCE

9 OUNCES MAX

#### DIELECTRIC WITHSTANDING VOLTAGE

1000 VAC MIN

#### INSULATION RESISTANCE

5000 MEGOHMS MIN

#### TEMPERATURE RATING

- 55 ~ + 125 °C

MIL-C-50	BRASS
MIL-C-576	COPPER
MIL-G-45204	GOLD PLATING
MIL-T-10727	TIN PLATING