

# DDLH SERIES

## D-SUB CONNECTOR, HIGH DENSITY STRAIGHT PCB TYPE, HIGH PROFILE

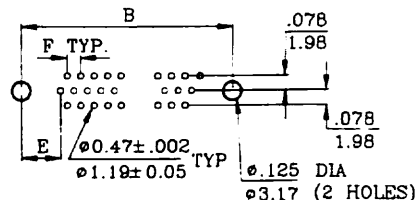

26, 44, 62 POSITIONS

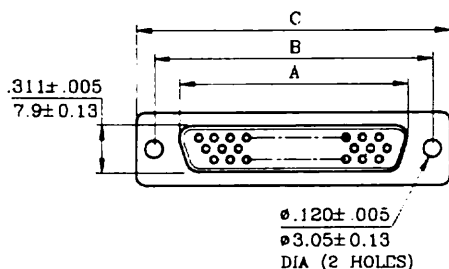
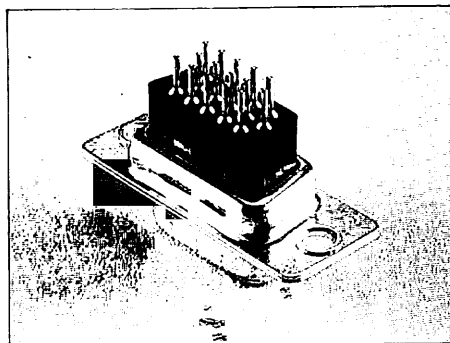
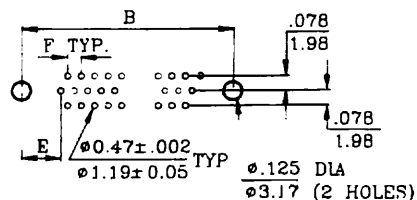

15 POSITIONS

PCB HOLE PATTERNS

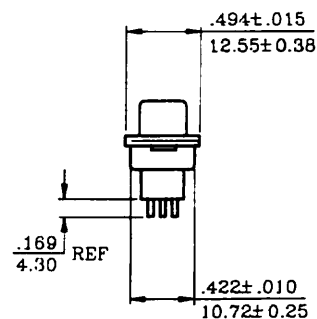
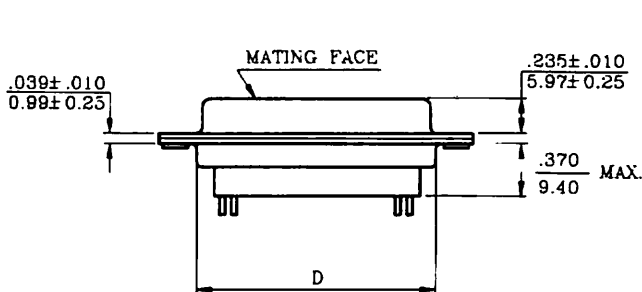

### DIMENSIONS

SHELL SIZE	No. of Contact Positions	A	B	C	D	E	F
		0.010 0.25	0.005 0.13	0.015 0.38	0.010 0.25	0.010 0.25	0.005 0.13
E	15	0.643 16.33	0.984 24.99	1.213 30.81	0.759 19.28	0.277 7.04	0.090 2.29
A	26	0.971 24.66	1.312 33.32	1.541 39.14	1.083 27.51	0.271 6.88	0.090 2.29
B	44	1.511 38.38	1.852 47.04	2.088 53.04	1.625 41.28	0.271 6.88	0.090 2.29
C	62	2.159 54.84	2.500 63.50	2.729 69.32	2.272 57.71	0.275 6.99	0.095 2.41

• MOUNTING OPTIONS:  
SEE PAGE 46

# MOUNTING OPTION

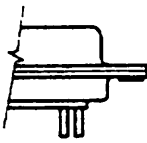

**OPTION X**  
 .120 DIAMETER HOLES

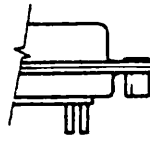

**OPTION K**  
 WITH #4-40 THREADED  
 RIVETED CLINCH NUTS

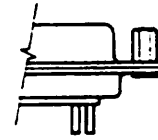

**OPTION J**  
 WITH #4-40  
 THREADED FIXED  
 JACK SCREWS

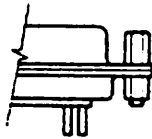

**OPTION KJ**  
 WITH #4-40 THREADED  
 RIVETED CLINCH NUTS  
 AND JACK SCREWS  
 ASSEMBLED TO  
 CONNECTOR

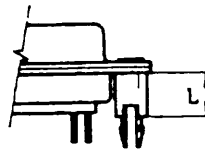

**OPTION BR**  
 WITH #4-40 THREADED  
 RIVETED BRACKETS

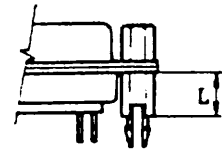

**OPTION BRJ**  
 WITH #4-40 THREADED  
 RIVETED BRACKET  
 AND JACK SCREWS  
 ASSEMBLED TO  
 CONNECTOR

SERIES	MOUNTING OPTIONS
DDF	X, K, J, KJ, BR, BRJ (L = 8.50MM)
DDL	X, K, J, KJ, BR, BRJ (L = 14.50MM)
DSF	X, K, J, KJ
DCC	X, K, J, KJ
DS	X, K, J, KJ
DSH	X, K, J, KJ
DD	X, K, J, KJ, BR, BRJ (L = 6.00MM)
DDH	X, K, J, KJ, BR, BRJ (L = 6.00MM)
DDL	X, K, J, KJ, BR, BRJ (L = 11.00MM, 12.70MM)
DDLH	X, K, J, KJ, BR, BRJ (L = 9.65MM, 11.00MM, 12.70MM)
DC	X, K, J, KJ
DCH	X, K, J, KJ
DIDC	X, K, J, KJ
DMR	X, K, J, KJ
DMRM	X, K, J, KJ
DMRL	X, K, J, KJ

# HOW TO ORDER

$\frac{DR}{1} - \frac{A}{2} \frac{15}{3} \frac{S}{4} - \frac{NJ}{5} - \frac{0}{6} \frac{0}{7} \frac{0}{8} - \frac{C}{9}$

$\frac{DP}{1} - \frac{E}{2} \frac{9}{3} \frac{S}{4} / \frac{E}{2} \frac{15}{3} \frac{S}{4} - \frac{ANJ}{5} - \frac{0}{6} \frac{0}{7} \frac{0}{8} - \frac{C}{9}$  (DUAL PORT ONLY)

TOP CONNECTOR      BOTTOM CONNECTOR

## 1. SERIES

## 2. SHELL SIZE

E - - - - -	9	B - - - - -	25
A - - - - -	15	C - - - - -	37
G - - - - -	19	D - - - - -	50
F - - - - -	23		

## 3. NO. OF CONTACTS

9, 15, 19, 23, 25, 26, 37, 44, 50, 62, 78, 104

## 4. CONTACT TYPE

P : PIN CONTACT (PLUG), BRASS  
S : SOCKET CONTACT (RECEPTACLE), PHOSPHOR BRONZE  
SB : SOCKET CONTACT (RECEPTACLE), BRASS

## 5. MOUNTING OPTIONS

## 6. CONTACT FINISH

0: GOLD FLASH	4: 15 $\mu''$
1: SELECTIVE GOLD FLASH	5: 20 $\mu''$
2: 5 $\mu''$	6: 30 $\mu''$
3: 10 $\mu''$	

## 7. INSULATOR COLOR

0: BLACK	2: BLUE
1: WHITE	3: GREY

## 8. SHELL PLATED

0: TIN	2: ZINC
1: NICKEL	3: ALL PLASTIC

## 9. CUSTOMER'S DESIGN

---

## FEATURES

- MEETS EIA, RS232C AND RS449 STANDARDS FOR DATA COMMUNICATION INPUT/OUTPUT CONNECTORS
- BRIGHT TIN SHELLS FOR EXCEPTIONAL CONDUCTIVITY AND GROUNDING
- INDENTATIONS (DIMPLES) FOR EXCEPTIONAL GROUNDING AND MATING RETENTION
- D SHAPE CONNECTOR MATING AND POLARIZATION
- SEVEN (7) SHELL SIZES
- FIVE (5) TYPES OF CONTACT TERMINATION, SOLDER CUP, SOLDER DIP, CRIMP, IDC AND RIGHT ANGLE
- TWO (2) TYPES OF CONTACT CONSTRUCTION, PRECISION MACHINED OR PRECISION FORMED
- ACCESSORIES ARE AVAILABLE

## PERFORMANCE SPECIFICATIONS

### MATERIALS AND FINISH

#### SHELL

STEEL MATERIAL, TIN FINISH AND IDENTIFICATIONS (DIMPLES) ON PLUG ONLY

#### INSERT

PBT THERMO PLASTIC, BLACK COLOR, 30% GLASS FILLED SELF EXTINGUISHING, 94V-0 RATED

#### CONTACT MATERIAL

PIN : BRASS  
SOCKET: PHOSPHOR BRONZE OR BRASS

### MECHANICAL CHARACTERISTICS

#### CONTACT RETENTION

PRECISION MACHINED CONTACT 10 LBS  
PRECISION FORMED CONTACT 10 LBS

#### CONTACT SEPARATION FORCE

4 OUNCES MIN

### ELECTRICAL CHARACTERISTICS

#### CONTACT CURRENT RATING

PRECISION MACHINED CONTACT 7.6 AMPS (WITH 20 AWG WIRE)  
PRECISION FORMED CONTACT 5.0 AMPS (WITH 20 AWG WIRE)

#### CONTACT RESISTANCE

PRECISION MACHINED CONTACT  
5 MILLIOHMS MAX  
PRECISION FORMED CONTACT  
8 MILLIOHMS MAX

### MILITARY AND FEDERAL SPECIFICATIONS

ASTM-B633	ZINC PLATING
QQ-B750	PHOSPHOR BRONZE
QQ-N-290	NICKEL PLATING
QQ-S-698	STEEL

#### CONTACT FINISH

GOLD FLASH OVER 100 MICRO INCH  
NICKEL ON ENTIRE CONTACT AREA.

#### GROUNDING BRACKET

BRASS MATERIAL, TIN FINISH

#### RIVETED INSERT

BRASS MATERIAL, NICKEL FINISH

#### JACK SCREW

BRASS MATERIAL,

#### CONTACT ENGAGEMENT FORCE

9 OUNCES MAX

#### DIELECTRIC WITHSTANDING VOLTAGE

1000 VAC MIN

#### INSULATION RESISTANCE

5000 MEGOHMS MIN

#### TEMPERATURE RATING

- 55 ~ + 125 °C

MIL-C-50	BRASS
MIL-C-576	COPPER
MIL-G-45204	GOLD PLATING
MIL-T-10727	TIN PLATING